

AXIAL
IP67 M12 CONNECTOR
IEC 61076-2-101
(CODE 'J')

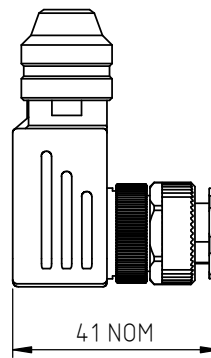

AXIAL VERSION
109.7 + STROKE
SPRING RETURN/EXTEND (CODE 'S'/'R')
147.7 + STROKE (<150 STROKE)
192.7 + STROKE (>150 STROKE)

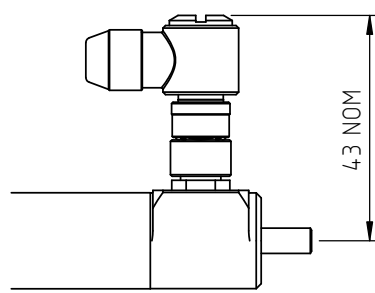
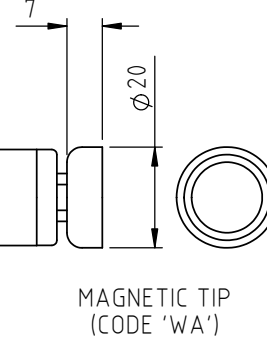

RADIAL
IP67 M8 CONNECTOR
IEC 61076-2-104
(CODE 'KA')

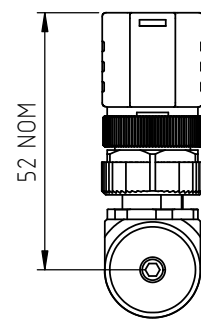

RADIAL
IP67 M12 CONNECTOR
IEC 61076-2-101
(CODE 'K')

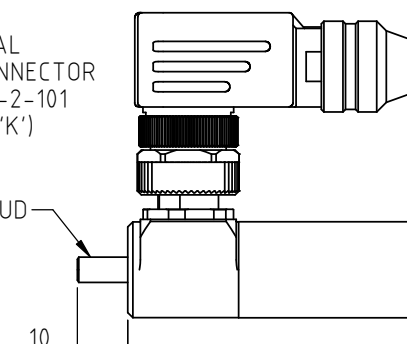

RADIAL VERSION
118.5 + STROKE
SPRING RETURN/EXTEND (CODE 'S'/'R')
156.5 + STROKE (<150 STROKE)
201.5 + STROKE (>150 STROKE)

DOME END
(CODE 'T')

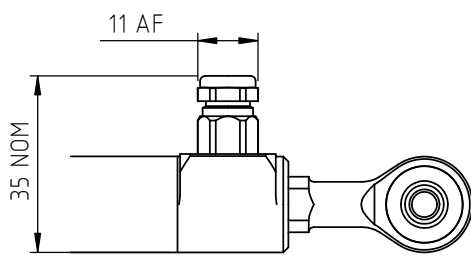
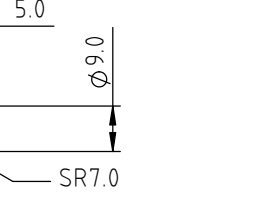

RADIAL
IP67 (M8) CABLE GLAND
(CODE 'IBxx'/'IBQxx')

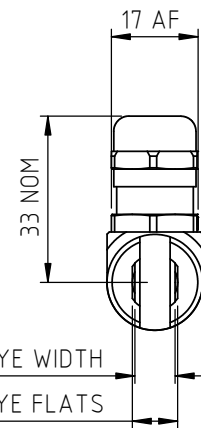

8.0 ROD EYE WIDTH
9.0 ROD EYE FLATS

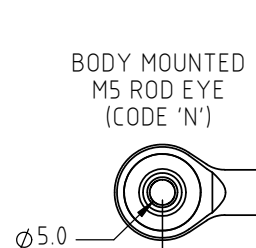

BODY MOUNTED
M5 ROD EYE
(CODE 'N')

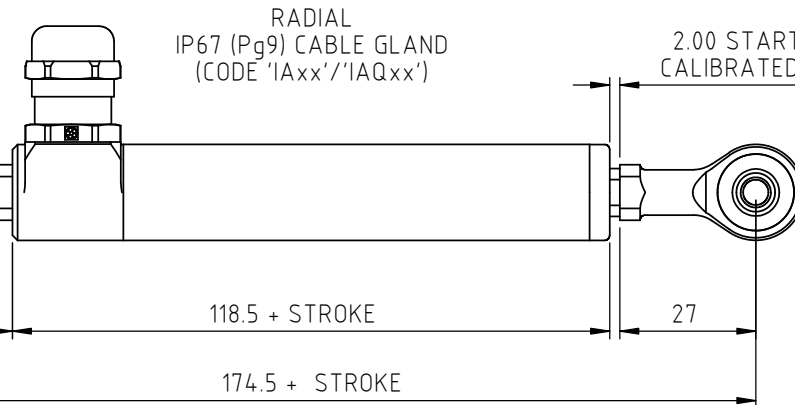

RADIAL
IP67 (Pg9) CABLE GLAND
(CODE 'IAxx'/'IAQxx')

2.00 START OF
CALIBRATED O/P

PUSH-ROD MOUNTED
M5 ROD EYE
(CODE 'U')

ELECTRICAL OPTIONS/ SPECIFICATIONS

OUTPUT	SUPPLY (NOM.)	
'A' 0.5 - 4.5V RATIOMETRIC	5V	
SUPPLY CURRENT 12mA TYP. 20mA MAX.		
CONNECTIONS:	CABLE 3-CORE	CABLE 5-CORE
+Ve	RED	RED
+ SENSE (5-WIRE ONLY)	-	ORANGE
0V	BLACK	BLACK
- SENSE (5-WIRE ONLY)	-	GREY
OUTPUT	WHITE	WHITE
BODY	SCREEN	SCREEN
	CONNECTOR	
	:1	
	:1	
	:3	
	:3	
	:2	
	:4	

CABLE: 0.2mm², O/A SCREEN, PUR JACKET, SUPPLIED WITH 50cm OR REQUIRED LENGTH IN cm (15000cm MAX).
STANDARD 3-CORE: BLACK Ø4mm JACKET e.g. L50
OPTIONAL 5-CORE: BLUE Ø4.6mm JACKET e.g. LQ50
CONNECTORS: MAXIMUM CONDUCTOR CROSS SECTION 0.25mm²

RANGE OF DISPLACEMENT FROM 0-2mm TO 0-350mm
IN INCREMENTS OF 1mm e.g.36.
BODY MATERIAL:- STAINLESS STEEL.

FURTHER OPTIONS:
SINGLE PAIR OF BODY CLAMPS (CODE 'P')
TWO PAIRS OF BODY CLAMPS (CODE 'P2')
SPRING RETURN PUSH-ROD, TRAVEL ≤ 300mm
RETURN TO EXTENDED POSITION (CODE 'R')
RETURN TO RETRACTED POSITION (CODE 'S')

DOME END* (CODE 'T') IN CONJUNCTION WITH SPRUNG PUSH-ROD (CODE 'R')
PUSH-ROD FREE (CODE 'V') N.b. NOT AVAILABLE WITH SPRUNG OPTION.
MAGNETIC TIP (CODE 'WA')

NOTE: ROD-EYE ORIENTATION RELATIVE TO GLAND/CONNECTOR NOT GUARANTEED.
THE PUSH-ROD RETRACTS AND EXTENDS 2mm NOM. AT EITHER END OF CALIBRATED TRAVEL.
'V' CODED PUSH-ROD WILL DEPART SENSOR BODY

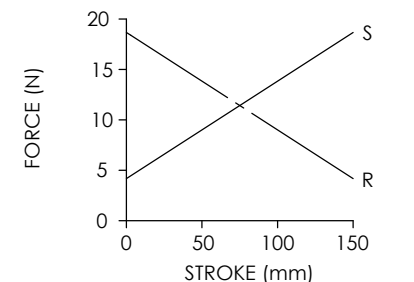

SPRING FORCE VS STROKE
(CODE 'R' OR 'S' <150mm STROKE)

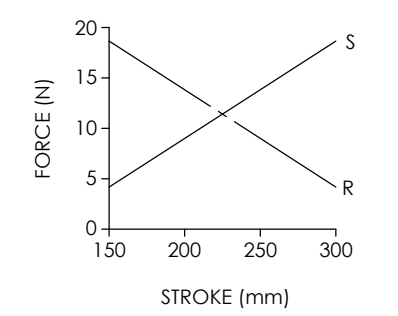

SPRING FORCE VS STROKE
(CODE 'R' OR 'S' >150mm STROKE)

NOTE:- READ INSTALLATION SHEET E117-19 FOR FULL INSTRUCTIONS FOR USE.

ATEX / IECEx / UKEX APPROVED TO
Ex II 1GD
Ex ia IIC T4 Ga (Ta= -40° to +80°C)
Ex ia IIIC T135°C Da (Ta= -40° to +80°C)
Ui 11.4V, Ii 0.2A, Pi 0.51W

APPROVED FOR USE IN CONJUNCTION WITH A GALVANICALLY ISOLATED BARRIER.

NOTE: APPROVAL ONLY APPLIES AT NORMAL ATMOSPHERIC PRESSURE!



APPROVED BY RDM	REV K		X ±0.4 X.X ±0.2 X.XX ±0.1 DIMS mm
DESCRIPTION E117 INTRINSICALLY SAFE SLIM LINE LINEAR POSITION SENSOR			
SCALE A3	2:3	DRAWING NUMBER E117-11	
SHEET 1 OF 1			

DRAWINGS NOT TO BE CHANGED WITHOUT REFERENCE TO THE CHANGE PROCEDURE.
CHANGES TO PARTS USED IN INTRINSICALLY SAFE PRODUCT MUST BE APPROVED BY THE AUTHORISED PERSON.
THIS IS AN UNCONTROLLED PRINT AND WILL NOT BE UPDATED.

REV	CHANGE HISTORY	DR'WN	DATE	CHK'D
K	ADDED SPRING RETURN/RADIAL END CAP/MAG TIP	ASC	23/09/2021	ASC



E117 SLIM-LINE LINEAR POSITION SENSOR

INTRINSICALLY SAFE FOR HAZARDOUS DUST ATMOSPHERES

- **Intrinsically safe for Gas and Dust to: Ex II 1GD**
- **Non-contacting inductive technology to eliminate wear**
- **Travel set to customer's requirement**
- **Compact 19 mm diameter body**
- **High accuracy and stability**
- **Sealing to IP67**



As a leading designer and manufacturer of linear, rotary, tilt and intrinsically safe position sensors, Positek® has the expertise to supply a sensor to suit a wide variety of applications.

Our E117 incorporates electronics system EX07 which is ATEX / IECEx / UKEX approved for use in potentially explosive **gas/vapour and dust** atmospheres.

The E117 is designed for industrial and scientific feedback applications and is ideal for OEMs seeking good sensor performance for arduous applications in hazardous areas.

Overall performance, repeatability and stability are outstanding over a wide temperature range. The unit is very compact and space-efficient with a small 19mm diameter body. The sensor is very robust, the body and push rod being made of stainless steel. The sensor is easy to install with mounting options including M5 male stud and M5 rod eye bearing. The push rod can be supplied free or captive, with male M5 thread, M5 rod eye or magnetic tip. Captive push rods can be sprung loaded in either direction. 1/4" rod eye option available. Like all Positek® sensors, the E117 provides a linear output proportional to travel. Each unit is supplied with the output calibrated to the travel required by the customer, from 5 to 350mm and with full EMC protection built in. The E117 offers a range of mechanical options, environmental sealing is to IP67.

SPECIFICATION

Dimensions

Body diameter	19 mm
Body Length (Axial version)	calibrated travel + 109.7 mm
sprung < 150mm stroke	calibrated travel + 147.7 mm
sprung ≥ 150mm stroke	calibrated travel + 192.7 mm
(Radial version)	calibrated travel + 118.5 mm
sprung < 150mm stroke	calibrated travel + 156.5 mm
sprung ≥ 150mm stroke	calibrated travel + 201.5 mm
Push rod extension	calibrated travel + 2 mm, OD 9.5 mm

For full mechanical details see drawing E117-11

Independent Linearity ≤ ± 0.25% FSO @ 20°C

Temperature Coefficients < ± 0.01%/°C Gain &

< ± 0.01%FS/°C Offset

> 10 kHz (-3dB)

Frequency Response

Resolution Infinite

Noise < 0.02% FSO

Intrinsic Safety Ex II 1GD

Ex ia IIC T4 Ga (Ta= -40°C to 80°C)

Ex ia IIIC T135°C Da (Ta= -40°C to 80°C)

Approval only applies to the specified ambient temperature range and atmospheric conditions in the range 0.80 to 1.10 Bar, oxygen ≤ 21%

Sensor Input Parameters Ui: 11.4V, Ii: 0.20A, Pi: 0.51W.

(connector option/s) Ci: 1.16µF, Li: 50µH

(cable option/s) Ci: 1.36µF, Li: 860µH with 1km max. cable

Environmental Temperature Limits

Operating -40°C to +80°C

Storage -40°C to +125°C

Sealing IP67

EMC Performance

EN 61000-6-2, EN 61000-6-3

Vibration IEC 68-2-6: 10 g

Shock IEC 68-2-29: 40 g

MTBF 350,000 hrs 40°C Gf

Drawing List

E117-11 Sensor Outline

3D models, step or .igs format, available on request.

Do you need a position sensor made to order to suit a particular installation requirement or specification? We'll be happy to modify any of our designs to suit your needs - please contact us with your requirements.



For further information please contact:

www.positek.com sales@positek.com

Tel: +44(0)1242 820027 fax: +44(0)1242 820615

Positek, Andoversford Industrial Estate, Cheltenham GL54 4LB. U.K.

E117-17r

1 of 3



E117 SLIM-LINE LINEAR POSITION SENSOR

INTRINSICALLY SAFE FOR HAZARDOUS DUST ATMOSPHERES

Intrinsically safe equipment is defined as "equipment which is incapable of releasing sufficient electrical or thermal energy under normal or abnormal conditions to cause ignition of a specific hazardous atmosphere mixture in its most easily ignited concentration."

ATEX / IECEx / UKEX approved to;

- Ex II 1GD
- Ex ia IIC T4 Ga (Ta= -40°C to 80°C)
- Ex ia IIIC T135°C Da (Ta= -40°C to 80°C)

Designates the sensor as belonging to; Group II: suitable for all areas **except mining**, Category 1 GD: can be used in areas with continuous, long or frequent periods of exposure to hazardous gas / vapour (Zones 2 to 0) and dust (Zone 20).

Gas / Vapour:

Protection class ia, denotes intrinsically safe for all zones

Apparatus group IIC: suitable for IIA, IIB and IIC explosive gas / vapour.

Temperature class T4: maximum sensor surface temperature under fault conditions 135°C.

Dust:

T135°C: maximum sensor surface temperature under fault conditions.

Ambient temperature range extended to -40°C to +80°C.

It is imperative Positek® intrinsically safe sensors be used in conjunction with a galvanic barrier to meet the requirements of the product certification. The Positek X005 Galvanic Isolation Amplifier is purpose made for Positek IS sensors making it the perfect choice. Refer to the X005 datasheet for product specification and output configuration options.

For cable lengths exceeding 10 metres a five wire connection is recommended to eliminate errors introduced by cable resistance and associated temperature coefficients.

ATEX / IECEx / UKEX approved sensors suitable for gas (X series) and mining (M series) applications, are also available from Positek.

E117	a	b	c	d	e	f	g	h	j
	Displacement	A	Connections	Option	Option	Option	Option	Option	Z000

<p>a Displacement Value</p> <p>Factory set to any length from 0-5 mm to 0-350 mm (e.g. 0-76 mm) 76</p> <p>b Output</p> <table style="width: 100%;"> <thead> <tr> <th style="text-align: left;">Supply V_{dc} (tolerance)</th> <th style="text-align: left;">Output</th> <th style="text-align: left;">Code</th> </tr> </thead> <tbody> <tr> <td>+5V (4.5 - 5.5V)</td> <td>0.5 - 4.5V (ratiometric with supply)</td> <td>A</td> </tr> </tbody> </table> <p>Supply Current 10mA typical, 12mA max.</p> <p>c Connections Code</p> <p>Cable gland radial IP67 Pg9, metal, 3-core cable IAxx</p> <p>Cable gland radial IP67 Pg9, metal, 5-core cable IAQxx</p> <p>Cable gland radial IP67 M8, metal, 3-core cable IBxx</p> <p>Cable gland radial IP67 M8, metal, 5-core cable IBQxx</p> <p>Connector axial IP67 4 pin M12 IEC 61076-2-101, metal J</p> <p>Connector axial IP67 4 pin M12 IEC 61076-2-101, metal, pre-wired 3-core cable Jxx</p> <p>Connector axial IP67 4 pin M12 IEC 61076-2-101, metal, pre-wired 5-core cable JQxx</p> <p>Connector radial IP67 4 pin M12 IEC 61076-2-101, metal K</p> <p>Connector radial IP67 4 pin M12 IEC 61076-2-101, metal, pre-wired 3-core cable Kxx</p> <p>Connector radial IP67 4 pin M12 IEC 61076-2-101, metal, pre-wired 5-core cable KQxx</p> <p>Connector radial IP67 4 pin M8 IEC 61076-2-104, metal KA</p> <p>Connector radial IP67 4 pin M8 IEC 61076-2-104, metal, pre-wired 3-core cable KAxx</p>	Supply V_{dc} (tolerance)	Output	Code	+5V (4.5 - 5.5V)	0.5 - 4.5V (ratiometric with supply)	A	<p>c Connections <small>continued</small> Code</p> <p>Cable gland axial IP67 Pg9, metal, 3-core cable Lxx</p> <p>Cable gland axial IP67 Pg9, metal, 5-core cable LQxx</p> <p><small>Specify required cable length 'xx' in cm. e.g. L2000 specifies axial cable gland with 20 m of cable, 50 cm supplied as standard. Note! maximum length supplied 15000cm. N.b.! M8 connector option with 5-core cable not available.</small></p> <p>d Body Fittings Code</p> <p>None axial version or Male Thread M5x0.8x10 long radial version default blank</p> <p>M5 Rod-eye bearing radial version only N</p> <p>e Body Clamps Code</p> <p>None default blank</p> <p>Body Clamps 1 pair P</p> <p>f Sprung Push Rod Code</p> <p>Not sprung default blank</p> <p>Spring extend R</p> <p>Spring retract S</p> <p><small>Captive push rod only. Note! sensor length change.</small></p> <p>g Push Rod Fittings Code</p> <p>Male thread M5x0.8x10 long default blank</p> <p>Dome end with spring extend option 'R' T</p> <p>M5 Rod-eye Bearing U</p> <p>Magnetic Tip WA</p> <p>h Push Rod Code</p> <p>Captive push rod retained default blank</p> <p>Non-captive push rod can depart body V</p> <p>j Z-code Code</p> <p>Calibration to suit X005 required Z000</p> <p>$\leq \pm 0.1\%$ FSO @20°C Independent Linearity 0 - 10 mm min. Z650</p> <p>1/4" Rod eyes with options 'N' and/or 'U' Z827</p>
Supply V_{dc} (tolerance)	Output	Code					
+5V (4.5 - 5.5V)	0.5 - 4.5V (ratiometric with supply)	A					

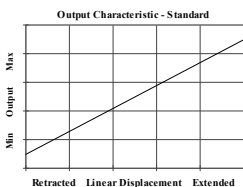

For further information please contact:

www.positek.com sales@positek.com

Tel: +44(0)1242 820027 fax: +44(0)1242 820615

Positek, Andoversford Industrial Estate, Cheltenham GL54 4LB. U.K.



Three or Five-Wire Mode Connection

FOR INTRINSICALLY SAFE SENSORS IN HAZARDOUS ATMOSPHERES

The aim of this document is to help readers who do not understand what is meant by three or five wire modes of connection between the galvanic isolation amplifier and sensor, and the factors behind them. It is by no means an in-depth technical analysis of the subject.

Whether opting for a pre-wired Positek® Intrinsicly Safe sensor or one with a connector, choosing the right mode of connection and cable to suit the application requires careful consideration.

Interconnecting cables are not perfect conductors and offer resistance to current flow, the magnitude of resistance[†] depends on conductors resistivity, which changes with temperature, cross sectional area[‡] and length. If the voltage were to be measured at both ends of a length of wire it would be found they are different, this is known as volts drop. Volts drop changes with current flow and can be calculated using Ohm's law, it should be noted that volts drop occurs in both positive and negative conductors. The effects of volts drop can be reduced by increasing the conductors cross sectional area, this does not however eliminate the effects due to temperature variation. There are instances where large cross-section cables are not practical; for example most standard industrial connectors of the type used for sensors have a maximum conductor capacity of 0.75mm², copper prices and ease of installation are other considerations.

This is important because the effects of volts drop can significantly alter the perceived accuracy of the sensor which is ratiometric i.e. the output signal is directly affected by the voltage across the sensor. Changes in temperature will also be seen as gain variation in the sensor output.

Three wire mode connections are common and are suitable in most cases with short or moderate cable runs. Applications that do not require a high degree of accuracy but have cable runs, say in excess of 10m, volts drop can be reduced by introducing a terminal box close to the sensor and using a larger cross-section cable for a majority of the cable run. Sensors supplied with three core cable are calibrated with the cable fitted which largely eliminates errors due to conductor resistance at room temperature however, as mentioned above, small gain errors due to temperature fluctuations should be expected.

Five wire mode connections have significant benefits as losses in the positive and negative conductors are compensated for by the galvanic isolation amplifier which can 'sense' the voltage across the sensor and dynamically adjust the output voltage so that the voltage across the sensor is correct. The effects of cable resistance and associated temperature coefficients are eliminated allowing for smaller conductors than a three wire connection for the same cable run. The amplifier can compensate for up to 15Ω per conductor with a current flow of 15mA, which is more than adequate for 150m of 0.25 mm² cable, longer lengths will require larger conductors.

For this reason Positek® recommends five wire connections for cable lengths exceeding 10 metres in 0.25 mm² cable to preserve the full accuracy of the sensor.

See illustrations below for examples of connecting a sensor to the galvanic isolation amplifier.

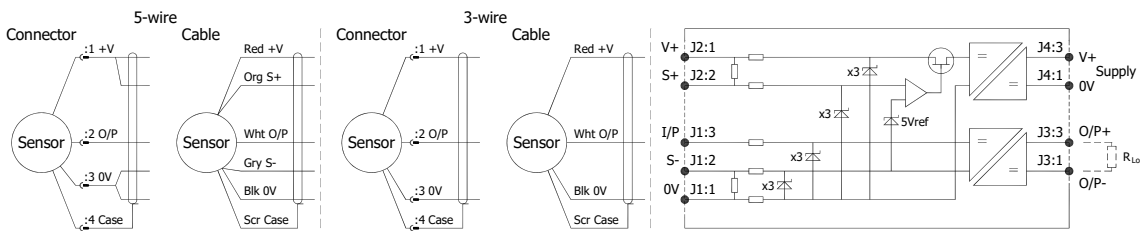

Cable Length (metres)	Up to 150	150 - 300	300 - 450	450 - 600	600 - 900	900 - 1000
Cross Section (mm ²)	0.25	0.5	0.75	1.0	1.5	2.0

The table above shows recommended conductor sizes with respect to cable length for both three and five wire connections, based on copper conductors. Three wire connections will introduce a gain reduction of 5% and a ±1% temperature dependence of gain over the range -40°C to +80°C for the cable temperature. (i.e. about -150 ppm/°C for the maximum lengths shown and less pro rata for shorter lengths.)

It should be noted that the maximum cable length, as specified in the sensor certification, takes **precedence** and **must not** be exceeded.

Positek® sensors are supplied with three core 0.25 mm² cable as standard, however five core 0.25 mm² cable can be supplied on request. The galvanic isolation amplifier is available as;

- G005-*** for 'G' and 'H' prefix sensors
- X005-*** for 'E', 'M' and 'X' prefix sensors

[†] $R = \rho L/A$ ρ is the resistivity of the conductor (Ωm) L is the length of conductor (m) A is the conductor cross-sectional area (m²).

[‡] It is presumed that direct current flow is uniform across the cross-section of the wire, the galvanic isolation amplifier and sensor are a dc system.



For further information please contact:

www.positek.com sales@positek.com

Tel: +44(0)1242 820027 fax: +44(0)1242 820615

Positek, Andoversford Industrial Estate, Cheltenham GL54 4LB. U.K.



Installation Information

E117 SLIM-LINE LINEAR POSITION SENSOR

INTRINSICALLY SAFE FOR HAZARDOUS DUST ATMOSPHERES

For certificate number and safety parameters information for product marked EX04, see next page.

ATEX / IECEx / UKEX Qualified to Intrinsic Safety Standard Certificate numbers SIRA 13ATEX2371X IECEX SIR 13.0154X CSAE 21UKEX2537X		Ex II 1GD Ex ia IIC T4 Ga (Ta = -40°C to +80°C) Ex ia IIIC T135°C Da (Ta = -40°C to +80°C)	
Electronics Version	Output Description:	Supply Voltage: Vs (tolerance)	Load resistance:
EX07	0.5 - 4.5V (ratiometric with supply) [Output code 'A']	+5V (4.5 - 5.5V)	5kΩ min

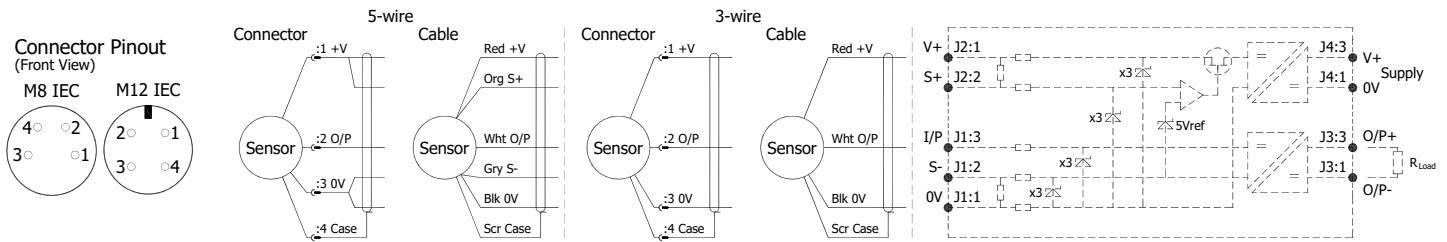

Putting Into Service: The sensor must be used with a galvanic isolation barrier designed to supply the sensor with a nominal 5V and to transmit the sensor output to a safe area. The barrier parameters must not exceed:-

U_i = 11.4V **I_i = 0.20A** **P_i = 0.51W**
C_i = 1.36μF* **Li = 860μH*** (with maximum cable length)
C_i = 1.16μF **Li = 50μH** (without cable)

*Figures for 1km cable where: C_i = 200pF/m & L_i = 810nH/m

The sensor is certified to be used with up to **1000m** of cable, cable characteristics must not exceed:-

Capacitance: ≤ 200 pF/m or max. total of: 200 nF
 Inductance: ≤ 810 nH/m or max. total of: 810 μH

Approval only applies to specified ambient temperature range and atmospheric conditions in the range: 0.80 to 1.10 Bar, oxygen ≤ 21%.

The performance of the sensor may be affected by voltage drops associated with long cable lengths; For cable lengths exceeding 10 metres a five wire connection is recommended to eliminate errors introduced by cable resistance and associated temperature coefficients.

Warning - The M12 IEC connector may be rotated for purposes of convenient orientation of the connector and cable, however rotating the connector more than one complete revolution is not recommended. **Repeated rotation of the connector will damage the internal wiring!**

Special Condition for Safe Use:

The apparatus does not meet the 500 V r.m.s dielectric strength test between circuit and frame, in accordance with clause 6.3.13 of IEC 60079-11:2011. This must be taken into consideration on installation.

When using a Sensor that has an integral cable in a dust application, the free end of the cable shall be appropriately terminated for the zone of use. Under certain extreme circumstances, the non-metallic and isolated metal parts incorporated in the enclosure of this equipment may generate an ignition-capable level of electrostatic charge. Therefore the equipment shall not be installed in a location where the external conditions are conducive to the build-up of electrostatic charge on such surfaces. This is particularly important if the equipment is installed in a zone 0 location. In addition, the equipment shall only be cleaned with a damp cloth.

Use: The sensor is designed to measure linear displacement and provide an analogue output signal.

Assembly and Dismantling: The unit is not to be serviced or dismantled and re-assembled by the user.

Maintenance: No maintenance is required.

Mechanical Mounting: Depending on options; Body can be mounted by M5x0.8 male thread, rod eye bearing or by clamping the sensor body - body clamps are available, if not already ordered. Target by M5x0.8 male thread, rod eye bearing or magnetic tip. It is assumed that the sensor and target mounting points share a common earth.

Output Characteristic: Target is extended 2 mm from end of body at start of normal travel. The output increases as the target extends from the sensor body, the calibrated stroke is between 5 mm and 350 mm.

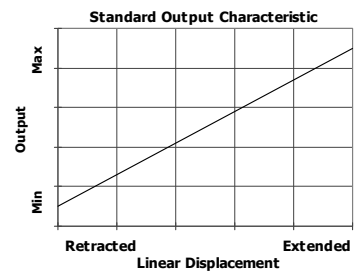

Incorrect Connection Protection levels: Not protected – the sensor is **not** protected against either reverse polarity or over-voltage. The risk of damage should be minimal where the supply current is limited to less than 50mA.



For further information please contact:

www.positek.com sales@positek.com

Tel: +44(0)1242 820027 fax: +44(0)1242 820615

Positek, Andoversford Industrial Estate, Cheltenham GL54 4LB. U.K.



Installation Information

E117 SLIM-LINE LINEAR POSITION SENSOR

INTRINSICALLY SAFE FOR HAZARDOUS DUST ATMOSPHERES

For certificate number and safety parameters information for product marked EX07, see previous page.

ATEX Qualified to Intrinsic Safety Standard Certificate numbers SIRA 00ATEX2076X		Ex II 1GD EEx ia I/IIC T4 (Ta = -40°C to +80°C) Ex ia D 20 T135°C (Ta = -40°C to +80°C)	
Electronics Version	Output Description:	Supply Voltage: V _s (tolerance)	Load resistance:
EX04	0.5 - 4.5V (ratiometric with supply) [Output code 'A']	+5V (4.5 - 5.5V)	5kΩ min

The barrier parameters must not exceed:-

U_i = 11.4V **I_i = 0.20A** **P_i = 0.51W**
C_i = 1.36μF* **L_i = 710μH*** ('Lxx' option) *Figures for 1km cable
C_i = 1.16μF **L_i = 50μH** ('J' or 'K' options)

The sensor is certified to be used with up to **1000m** of cable, cable characteristics must not exceed:-

Capacitance: ≤ 200 pF/m for max. total of: 200 nF
Inductance: ≤ 660 nH/m for max. total of: 660 μH

With the exception of the certificate number and safety parameters above, all other notes regarding Putting Into Service, Use, Assembly and Dismantling etc. on previous page apply to sensors marked EX04 or EX07.



For further information please contact:
www.positek.com sales@positek.com
Tel: +44(0)1242 820027 fax: +44(0)1242 820615
Positek, Andoversford Industrial Estate, Cheltenham GL54 4LB. U.K.